

Model B[®] With CSR

Spring Roller-Type Screen with Controlled Screen Return



SPECIFICATION DATA

SUGGESTED SPECIFICATIONS: _____ projection screen(s), _____(H) x _____(W), wall or ceiling mounting type. Screen to have a powder coated white 22-gauge octagonal steel case with flat back design and fitted with end caps concealing roller ends with integral bearing surface to support roller and integral brackets for wall mounting by means of slotted screw holes and ceiling mounting by means of powder coated hanger rings. To be equipped with Controlled Screen Return (CSR) to control the return

speed of the screen into the case. Bottom of fabric shall be mounted securely into a powder coated tubular steel slat. Ends of slat shall be protected by plastic caps. A steel pull bail shall be attached to slat. A 36" (91 cm) pull cord with plastic knob is included. To have masking borders standard on flame retardant and mildew resistant fiberglass fabric. Fabric shall be mounted into a metal strip in a metal Camlok[®] roller system without tape, glue, staples or cords so that fabric can be easily replaced yet cannot be pulled from roller.

Video (NTSC 4:3) Format Dimensions

Viewing Area (H x w)		Nominal Diagonal		A - Overall Length of Case		B - Between Hanger Eyes		C - Brackets		D - Case Diameter (Width)		Approx. Ship. Wt.	
In.	Cm	In.	Cm	In.	Cm	In.	Cm	In.	Cm	In.	Cm	Lbs.	Kg
43" x 57"	109 x 145	72"	183	63½"	161	62½"	159	3½"	9.2	2¾"	7	16	7.3
50" x 67"	127 x 170	84"	213	73½"	186	72½"	184	3½"	9.2	2¾"	7	17	7.7
57" x 77"	145 x 196	96"	244	84½"	214	83½"	212	3½"	9.2	2¾"	7	25	11.3
60" x 80"	152 x 203	100"	254	87½"	222	86½"	220	3½"	9.2	2¾"	7	26	11.8
69" x 92"	175 x 234	120"	305	99½"	252	98½"	251	3½"	9.2	2¾"	7	29	13.2

HDTV (16:9) Format Dimensions

Viewing Area (H x w)		Nominal Diagonal		A - Overall Length of Case		B - Between Hanger Eyes		C - Brackets		D - Case Diameter (Width)		Approx. Ship. Wt.	
In.	Cm	In.	Cm	In.	Cm	In.	Cm	In.	Cm	In.	Cm	Lbs.	Kg
37½" x 67"	95 x 170	77"	196	73½"	186	72½"	184	3½"	9.2	2¾"	7	16	7.3
45" x 80"	114 x 203	92"	234	87½"	222	86½"	220	3½"	9.2	2¾"	7	25	11.3
52" x 92"	132 x 234	106"	269	99½"	252	98½"	251	3½"	9.2	2¾"	7	28	12.7

(16:10) Wide Format Dimensions

Viewing Area (H x w)		Nominal Diagonal		A - Overall Length of Case		B - Between Hanger Eyes		C - Brackets		D - Case Diameter (Width)		Approx. Ship. Wt.	
In.	Cm	In.	Cm	In.	Cm	In.	Cm	In.	Cm	In.	Cm	Lbs.	Kg
50" x 80"	127 x 203	94"	239	87½"	222	86½"	220	3½"	9.2	2¾"	7	24	10.9
57½" x 92"	146 x 234	109"	277	99½"	252	98½"	251	3½"	9.2	2¾"	7	26	12.3

Square Format Dimensions

Sizes (H x w)		A - Overall Length of Case		B - Between Hanger Eyes		C - Brackets		D - Case Diameter (Width)		Approx. Ship. Wt.	
In.	Cm	In.	Cm	In.	Cm	In.	Cm	In.	Cm	Lbs.	Kg
60" x 60"	152 x 152	63½"	161	62½"	159	3½"	9.2	2¾"	7	16	7.3
70" x 70"	178 x 178	73½"	186	72½"	184	3½"	9.2	2¾"	7	19	8.6
72" x 72"	183 x 183	75½"	191	74½"	190	3½"	9.2	2¾"	7	21	9.5
84" x 84"	213 x 213	87½"	222	86½"	220	3½"	9.2	2¾"	7	28	12.7
96" x 96"	244 x 244	99½"	252	98½"	251	3½"	9.2	2¾"	7	32	14.5

PRODUCT NOTES

- **Matte White, Video Spectra 1.5 , High Contrast Matte White and High Power®:** Surfaces will be seamless.
- Overall case length dimensions +/- 1/4" (6 mm).
- Specifications subject to change without notice.
- Hanger rings add 3/4" (19 mm) to the overall dimension C.
- Custom formats and sizes available upon request.
- **Optional Accessories:** to provide clearance: Furnish 6" (15 cm) heavy extension wall brackets to mount screen. To provide for keystone elimination: Furnish #11 or #23 adjustable extension wall brackets. Furnish magnetic tilt lock for keystone elimination.
- **NOTE:** Brackets also are used for mounting screen across a corner.

WHEN ORDERING, MARK APPROPRIATE SELECTIONS:

1. Select size from charts on the other side.
2. Select viewing surface (All Da-Lite surfaces are GREENGUARD GOLD Certified):

<input type="checkbox"/> Matte White	<input type="checkbox"/> Video Spectra 1.5
<input type="checkbox"/> High Contrast Matte White	<input type="checkbox"/> High Power®
3. Optional accessories:

<input type="checkbox"/> No. 6 Wall Bracket - 6" (15 cm) non-adjustable extension brackets (75#, 34 kg, per pair maximum) (black or white).	<input type="checkbox"/> Tilt-Lock for Keystone Elimination (used with extension brackets).
<input type="checkbox"/> No. 11 Wall Bracket - 10" or 14" (25 or 36 cm) non-adjustable extension brackets (75#, 34 kg, per pair maximum) (black or white).	<input type="checkbox"/> T-Bar Clip for drop ceilings (50#, 23.7 kg, per pair maximum) (black or white).
<input type="checkbox"/> No. 23 Adjustable Wall Bracket - 10", 14", 15 3/4", 18 1/4", 20" or 24" (25, 36, 40, 46, 51 or 61 cm) adjustable extension brackets (75#, 34 kg, per pair maximum) (black or white).	<input type="checkbox"/> Pull Rod - 38" (97 cm).
	<input type="checkbox"/> No borders (Black masking borders standard).
	<input type="checkbox"/> Black case (white standard).

PRODUCT VIEWS

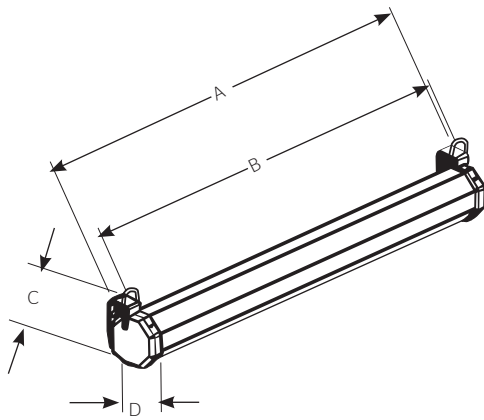

ACCESSORIES

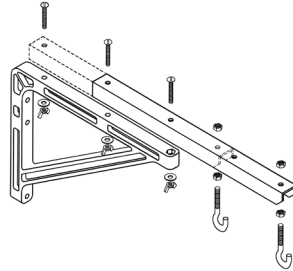

No. 23 Adjustable Wall Bracket
Screen can be extended 10", 14", 15 3/4", 18 1/4", 20" or 24" from wall by wing nut and bolt adjustment.

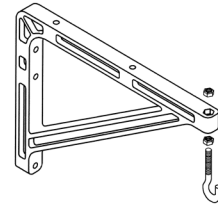

No. 11 Wall Bracket
Screen can be extended 10" or 14" from wall by changing position of bracket.

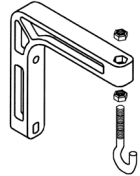

No. 6 Wall Bracket
Screen can be extended 6" from wall.

Extension Wall Brackets (75# Per Pair Maximum)

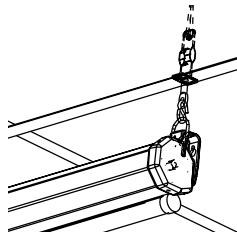

T-Bar Clip for drop ceiling, 50 lb. capacity.

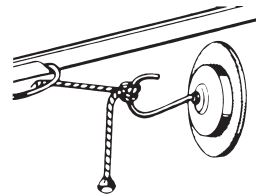

Tilt Lock for Keystone elimination. Used with extension brackets.

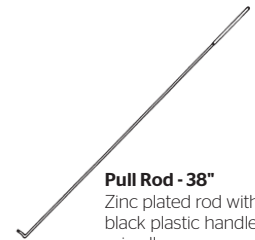

Pull Rod - 38"
Zinc plated rod with black plastic handle grip allows easy access to screen when mounted out of reach. Also can be used as a pointer.



A Milestone AV Technologies Brand

3100 North Detroit Street
Warsaw, Indiana 46582
P: 574.267.8101 or 800.622.3737
F: 574.267.7804 or 877.325.4832
E: info@da-lite.com
www.da-lite.com

DL-0225 11.13

© 2013 Milestone AV Technologies LLC. Printed in U.S.A.

Project Name:	_____
Architect:	_____
Contractor:	_____ Phone: _____
Reseller:	_____ Phone: _____